

ONKYO®

AM/FM Tuner

T-4555 *(European model)*

DAB/AM/FM Tuner

T-4555 *(U.K. model)*

Instruction Manual

Thank you for purchasing an Onkyo Tuner. Please read this manual thoroughly before making connections and plugging in the unit.

Following the instructions in this manual will enable you to obtain optimum performance and listening enjoyment from your new Tuner.

Please retain this manual for future reference.

Contents

Introduction 2

Connections 10

Enjoying Audio Sources..... 15

Troubleshooting 26

Specifications 27

WARNING:

TO REDUCE THE RISK OF FIRE OR ELECTRIC SHOCK, DO NOT EXPOSE THIS APPARATUS TO RAIN OR MOISTURE.

CAUTION:

TO REDUCE THE RISK OF ELECTRIC SHOCK, DO NOT REMOVE COVER (OR BACK). NO USER-SERVICEABLE PARTS INSIDE. REFER SERVICING TO QUALIFIED SERVICE PERSONNEL.



WARNING
RISK OF ELECTRIC SHOCK
DO NOT OPEN

AVIS
RISQUE DE CHOC ELECTRIQUE
NE PAS OUVRIR



The lightning flash with arrowhead symbol, within an equilateral triangle, is intended to alert the user to the presence of uninsulated "dangerous voltage" within the product's enclosure that may be of sufficient magnitude to constitute a risk of electric shock to persons.



The exclamation point within an equilateral triangle is intended to alert the user to the presence of important operating and maintenance (servicing) instructions in the literature accompanying the appliance.

Important Safety Instructions

1. Read these instructions.
2. Keep these instructions.
3. Heed all warnings.
4. Follow all instructions.
5. Do not use this apparatus near water.
6. Clean only with dry cloth.
7. Do not block any ventilation openings. Install in accordance with the manufacturer's instructions.
8. Do not install near any heat sources such as radiators, heat registers, stoves, or other apparatus (including amplifiers) that produce heat.
9. Do not defeat the safety purpose of the polarized or grounding-type plug. A polarized plug has two blades with one wider than the other. A grounding type plug has two blades and a third grounding prong. The wide blade or the third prong are provided for your safety. If the provided plug does not fit into your outlet, consult an electrician for replacement of the obsolete outlet.
10. Protect the power cord from being walked on or pinched particularly at plugs, convenience receptacles, and the point where they exit from the apparatus.
11. Only use attachments/accessories specified by the manufacturer.
12. Use only with the cart, stand, tripod, bracket, or table specified by the manufacturer, or sold with the apparatus. When a cart is used, use caution when moving the cart/apparatus combination to avoid injury from tip-over.

PORTABLE CART WARNING
S3125A
13. Unplug this apparatus during lightning storms or when unused for long periods of time.
14. Refer all servicing to qualified service personnel. Servicing is required when the apparatus has been damaged in any way, such as power-supply cord or plug is damaged, liquid has been spilled or objects have fallen into the apparatus, the apparatus has been exposed to rain or moisture, does not operate normally, or has been dropped.
15. Damage Requiring Service
Unplug the apparatus from the wall outlet and refer servicing to qualified service personnel under the following conditions:
 - A. When the power-supply cord or plug is damaged,
 - B. If liquid has been spilled, or objects have fallen into the apparatus,
 - C. If the apparatus has been exposed to rain or water,
 - D. If the apparatus does not operate normally by following the operating instructions. Adjust only those controls that are covered by the operating instructions as an improper adjustment of other controls may result in damage and will often require extensive work by a qualified technician to restore the apparatus to its normal operation,
 - E. If the apparatus has been dropped or damaged in any way, and
 - F. When the apparatus exhibits a distinct change in performance this indicates a need for service.
16. Object and Liquid Entry
Never push objects of any kind into the apparatus through openings as they may touch dangerous voltage points or short-out parts that could result in a fire or electric shock.
The apparatus shall not be exposed to dripping or splashing and no objects filled with liquids, such as vases shall be placed on the apparatus.
Don't put candles or other burning objects on top of this unit.
17. Batteries
Always consider the environmental issues and follow local regulations when disposing of batteries.
18. If you install the apparatus in a built-in installation, such as a bookcase or rack, ensure that there is adequate ventilation.
Leave 20 cm (8") of free space at the top and sides and 10 cm (4") at the rear. The rear edge of the shelf or board above the apparatus shall be set 10 cm (4") away from the rear panel or wall, creating a flue-like gap for warm air to escape.

Precautions

1. **Recording Copyright**—Unless it's for personal use only, recording copyrighted material is illegal without the permission of the copyright holder.
2. **AC Fuse**—The AC fuse inside the unit is not user-serviceable. If you cannot turn on the unit, contact your Onkyo dealer.
3. **Care**—Occasionally you should dust the unit all over with a soft cloth. For stubborn stains, use a soft cloth dampened with a weak solution of mild detergent and water. Dry the unit immediately afterwards with a clean cloth. Don't use abrasive cloths, thinners, alcohol, or other chemical solvents, because they may damage the finish or remove the panel lettering.
4. **Power**

WARNING

BEFORE PLUGGING IN THE UNIT FOR THE FIRST TIME, READ THE FOLLOWING SECTION CAREFULLY.

AC outlet voltages vary from country to country. Make sure that the voltage in your area meets the voltage requirements printed on the unit's rear panel (e.g., AC 230 V, 50 Hz or AC 120 V, 60 Hz).

The power cord plug is used to disconnect this unit from the AC power source. Make sure that the plug is readily operable (easily accessible) at all times.

For American Models

Pressing the [STANDBY/ON] button to select Standby mode does not fully shutdown the unit. If you do not intend to use the unit for an extended period, remove the power cord from the AC outlet.

5. **Never Touch this Unit with Wet Hands**—Never handle this unit or its power cord while your hands are wet or damp. If water or any other liquid gets inside this unit, have it checked by your Onkyo dealer.
6. **Handling Notes**
 - If you need to transport this unit, use the original packaging to pack it how it was when you originally bought it.
 - Do not leave rubber or plastic items on this unit for a long time, because they may leave marks on the case.
 - This unit's top and rear panels may get warm after prolonged use. This is normal.
 - If you do not use this unit for a long time, it may not work properly the next time you turn it on, so be sure to use it occasionally.

For British models

Replacement and mounting of an AC plug on the power supply cord of this unit should be performed only by qualified service personnel.

IMPORTANT

The wires in the mains lead are coloured in accordance with the following code:

Blue: Neutral

Brown: Live

As the colours of the wires in the mains lead of this apparatus may not correspond with the coloured markings identifying the terminals in your plug, proceed as follows:

The wire which is coloured blue must be connected to the terminal which is marked with the letter N or coloured black.

The wire which is coloured brown must be connected to the terminal which is marked with the letter L or coloured red.

IMPORTANT

The plug is fitted with an appropriate fuse. If the fuse needs to be replaced, the replacement fuse must be approved by ASTA or BSI to BS1362 and have the same ampere rating as that indicated on the plug. Check for the ASTA mark or the BSI mark on the body of the fuse. If the power cord's plug is not suitable for your socket outlets, cut it off and fit a suitable plug. Fit a suitable fuse in the plug.

For European Models

Declaration of Conformity	
We, ONKYO EUROPE ELECTRONICS GmbH LIEGNITZERSTRASSE 6, 82194 GROEBENZELL, GERMANY	
declare in own responsibility, that the ONKYO product described in this instruction manual is in compliance with the corresponding technical standards such as EN60065, EN55013, EN55020 and EN61000-3-2, -3-3.	
GROEBENZELL, GERMANY	
ONKYO EUROPE ELECTRONICS GmbH	

Memory backup

The T-4555 uses a battery-less memory backup system in order to retain radio presets and other settings when it's unplugged or in the case of a power failure.

Although no batteries are required, the T-4555 must be plugged into an AC outlet in order to charge the backup system.

Once it has been charged, the T-4555 will retain the settings for several weeks, although this depends on the environment and will be shorter in humid climates.

Features

- Tuner board upgrade capability
- 12V trigger IN/OUT
- RS232 port
- IR IN/OUT
- Hi-rigidity, anti-resonant chassis
- Aluminium front panel
- RI (Remote Interactive) capable

European Model

- Automatic AM/FM tuning
- 40 AM/FM presets
- RDS (Radio Data System)
- Preset auto scan
- Direct tuning

U.K. Model

- Automatic AM/FM/DAB tuning
- 40 AM/FM/DAB presets
- RDS (Radio Data System)
- DAB auto scanning (Band III/L-Band)
- Preset auto scan
- Direct tuning
- Ground isolation circuit for digital/analog

Supplied Accessories

Make sure you have the following accessories:

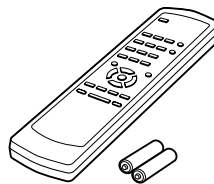

Remote controller and two batteries (AA/R6)

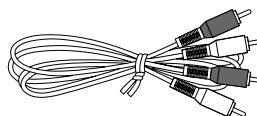

Audio cable (60 cm)

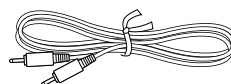

RI cable (60 cm)

To use **RI**, the T-4555 must be connected with an **RI** cable and an audio cable.

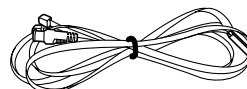

Indoor FM antenna

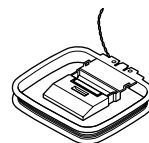

AM loop antenna



DAB antenna (with U.K. model)

* In catalogs and on packaging, the letter added to the end of the product name indicates the color of the T-4555. Specifications and operation are the same regardless of color.

Contents

Introduction

Important Safety Instructions	2
Precautions	3
Features	4
Supplied Accessories	4
Getting to Know the T-4555	6
Front Panel.....	6
Display.....	6
Rear Panel.....	7
Remote Controller	8
Remote Controller.....	8
Before Using the T-4555	9
Installing the Batteries.....	9
Aiming the Remote Controller.....	9

Connections

Connecting Antennas	10
Connecting the Indoor FM Antenna.....	10
Connecting the AM Loop Antenna.....	10
Connecting the T-4555	12
Connecting to an Amplifier.....	12
About the System Functions.....	12
Connecting the 12V Trigger Jacks.....	13
Controlling Components That Are Out of Range.....	14

Enjoying Audio Sources

Turning On and Listening to AM and FM Radio	15
Turning On the T-4555.....	15
Setting the Display Brightness.....	15
Listening to AM and FM Radio.....	15
Tuning into Stations by Frequency.....	16
Using RDS.....	17
Listening to DAB Digital Radio	19
DAB Setup.....	20
Using Presets	22
Presetting Your Favorite Stations.....	22
Selecting Presets.....	22
Deleting Presets.....	22
Changing the Remote ID	23
Optional Tuner Boards	24
AM Frequency Step Setup.....	24
Installing a Board.....	25

Others

Troubleshooting	26
If you can't resolve an issue, try resetting the AV receiver by holding down the [MEMORY] button and pressing the [STANDBY/ON] button.	
Specifications	27

Getting to Know the T-4555

Front Panel

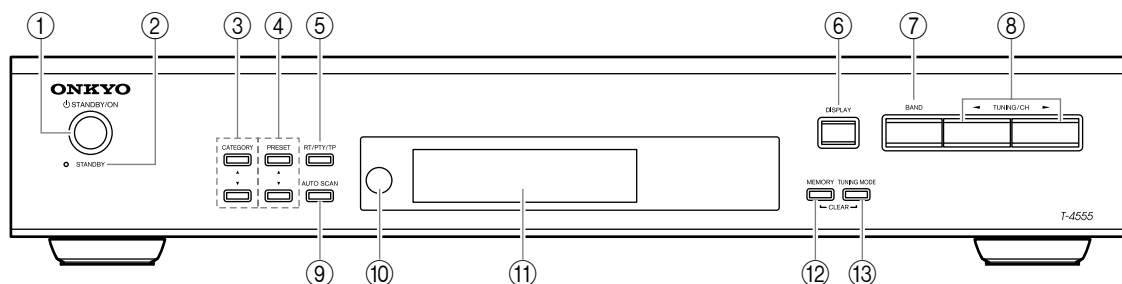

For detailed information, refer to the pages in parentheses.

- ① **STANDBY/ON button (15)**
Sets the T-4555 to On or Standby.
- ② **STANDBY indicator (15)**
Lights up when the T-4555 is on Standby.
- ③ **CATEGORY [▲]/[▼] buttons**
Selects categories for satellite radio.
As of August 2006, these buttons are not used on the European or U.K. T-4555.
- ④ **PRESET [▲]/[▼] buttons (18, 22)**
Used to select radio presets.
- ⑤ **RT/PTY/TP button (18)**
Used with RDS (Radio Data System).
- ⑥ **DISPLAY button (20)**
Used to view various information on the display.
- ⑦ **BAND button (15, 18, 19)**
Selects AM, FM, or DAB*.
- ⑧ **TUNING/CH [◀]/[▶] buttons (15, 19)**
With AM and FM, these buttons are used for tuning.
With DAB, they're used to select stations.
- ⑨ **AUTO SCAN button (18, 19, 22)**
Selects and outputs each radio preset in turn for 5 seconds. When tuned to an RDS FM station, it searches for stations by PTY (Program Type) or TP (Traffic Program). Also used to scan for available DAB stations.
- ⑩ **Remote control sensor (9)**
Receives control signals from the remote controller.
- ⑪ **Display**
See below.
- ⑫ **MEMORY button (22)**
Used to store and delete radio presets.
- ⑬ **TUNING MODE button (15, 22)**
Selects the Auto or Manual tuning mode for AM and FM radio.

*DAB requires C-DAB tuner board.

Display

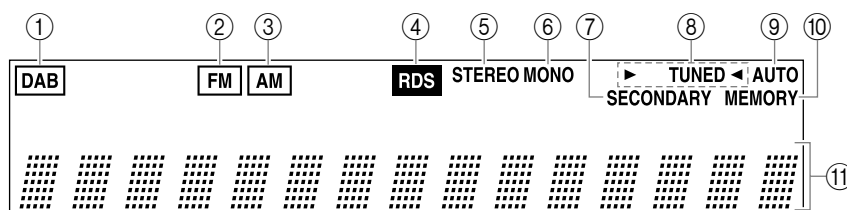

- ① **DAB (requires C-DAB tuner board)**
Lights up if the installed tuner board supports DAB.
When DAB is selected, a box appears around it.
- ② **FM**
Lights up if the installed tuner board supports FM.
When FM is selected, a box appears around it.
- ③ **AM**
Lights up if the installed tuner board supports AM.
When AM is selected, a box appears around it.
- ④ **RDS**
Lights up when the tuner is tuned to an FM radio station that supports RDS (Radio Data System).
- ⑤ **STEREO**
Lights up when radio reception is in stereo.
- ⑥ **MONO**
Lights up when radio reception is in mono.
- ⑦ **SECONDARY**
Lights up when tuned to an DAB station that's transmitting secondary multicast channels.
- ⑧ **▶ TUNED ◀**
The ▶ TUNED ◀ indicator lights up when properly tuned to a radio station. During Auto Tuning, the Tuning Arrows flash.
- ⑨ **AUTO**
Lights up when Auto Tuning mode is selected.
- ⑩ **MEMORY**
Lights up when presetting radio stations.
- ⑪ **Message area**
Various information is displayed here, including radio preset numbers, tuning frequency, and so on.

Rear Panel

■ European Model

Comes with C-AMFM tuner board installed.

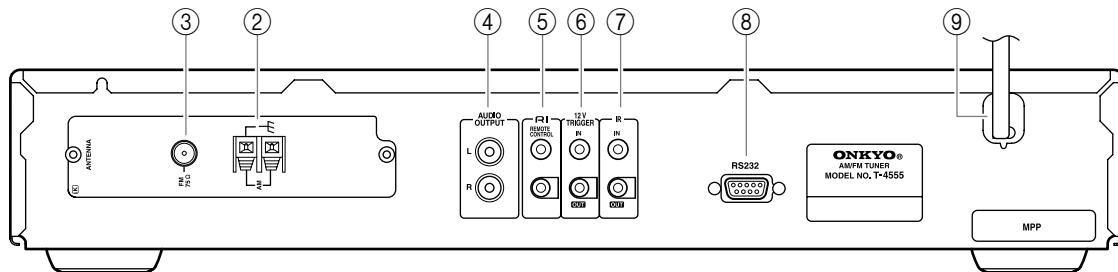

■ U.K. Model

Comes with C-DAB tuner board installed.

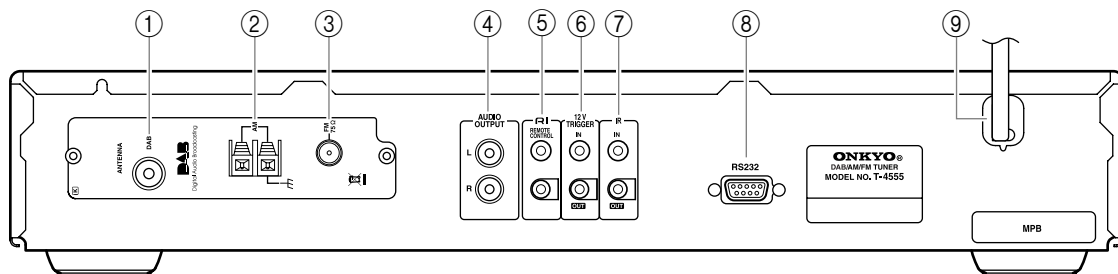

For detailed information, refer to the pages in parentheses.

① **DAB ANTENNA (C-DAB tuner board only) (11)**

This jack is for connecting the supplied DAB antenna.

② **AM ANTENNA (10)**

These push terminals are for connecting the supplied AM loop antenna or an outdoor AM antenna.

③ **FM 75Ω ANTENNA (10)**

This jack is for connecting the supplied indoor FM antenna or an outdoor FM antenna.

④ **AUDIO OUTPUT (12)**

Using the supplied audio cable, connect these output jacks to an analog audio input on your amp.

⑤ **RI REMOTE CONTROL (13)**

These two identical **RI** (Remote Interactive) jacks can be connected to the **RI** jacks on your other Onkyo components for interactive control. To use **RI**, the T-4555 must be connected with an **RI** cable and an audio cable.

⑥ **12V TRIGGER IN/OUT (13)**

The 12V TRIGGER IN jack can be connected to the 12-volt trigger output on another component, so that when the other component is turned on, the T-4555 turns on as well.

The 12V TRIGGER OUT jack can be connected to the 12-volt trigger input on another component, so that when the T-4555 is turned on, the other component turns on as well.

⑦ **IR IN/OUT (14)**

A commercially available IR receiver can be connected to the IR IN jack, allowing you to control the T-4555 while you're in another room, or control it when it's out of sight, for example, installed in a cabinet.

A commercially available IR emitter can be connected to the IR OUT jack to pass IR (infrared) remote control signals through to other components.

⑧ **RS232**

This port is for connecting the T-4555 to home automation equipment and external controllers.

⑨ **Power cord (15)**

The power cord should be connected to a suitable wall outlet.

See pages 10–14 for connection information.

Remote Controller

Remote Controller

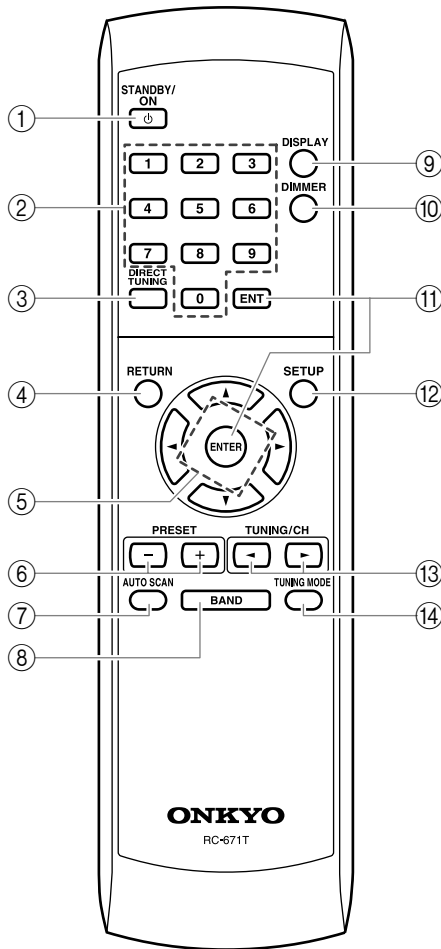

- ① **STANDBY/ON button (15)**
Sets the T-4555 to On or Standby.
- ② **Number buttons (16, 23)**
Used to select radio presets by number, and to enter AM/FM station frequencies and DAB channel numbers in Direct Tuning mode.
- ③ **DIRECT TUNING button (16)**
Selects the Direct Tuning mode. With AM and FM, you can select a station directly by entering its frequency. Direct Tuning mode does not work with DAB.
- ④ **RETURN button (23)**
Returns to the previous display.
- ⑤ **Arrow [▲]/[▼]/[◀]/[▶] buttons (20, 21, 23, 24)**
With AM and FM, the Up and Down [▲]/[▼] buttons are used for tuning. With DAB, the Up and Down [▲]/[▼] buttons are used to select stations. The Left and Right [◀]/[▶] buttons are not used by the C-AMFM and C-DAB tuner boards.
- ⑥ **PRESET [+]/[-] buttons (22)**
Used to select radio presets.
- ⑦ **AUTO SCAN button (19, 22)**
Scans for DAB stations or FM stations that support RDS.
- ⑧ **BAND button (15, 19)**
Selects AM, FM, or DAB*.
- ⑨ **DISPLAY button (20)**
Used to change the information shown on the display.
- ⑩ **DIMMER button (15)**
Adjusts the display brightness.
- ⑪ **ENT and ENTER buttons (20, 21, 23, 24)**
Used to confirm various functions and settings.
- ⑫ **SETUP button (20, 23, 24)**
Selects Setup mode.
- ⑬ **TUNING/CH [◀]/[▶] buttons (15, 19)**
With AM and FM, these buttons are used for tuning. With DAB, they're used to select stations.
- ⑭ **TUNING MODE button (15)**
Selects the Auto or Manual Tuning mode for AM and FM radio.

*DAB requires C-DAB tuner board.

Before Using the T-4555

Installing the Batteries

- 1 Open the battery compartment, as shown.

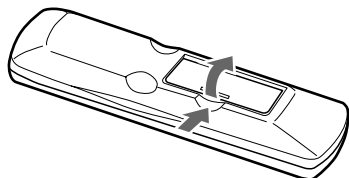

- 2 Insert the two supplied batteries (AA) in accordance with the polarity diagram inside the battery compartment.

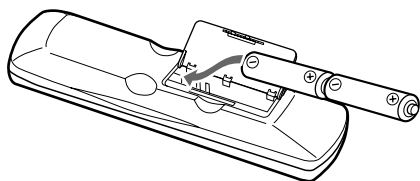

- 3 Close the battery compartment.

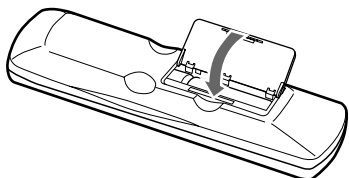

Notes:

- If the remote controller doesn't work reliably, try replacing the batteries.
- Don't mix new and old batteries or different types of batteries.
- If you intend not to use the remote controller for a long time, remove the batteries to prevent damage from leakage and corrosion.
- Flat batteries should be removed as soon as possible to prevent damage from leakage and corrosion.

Aiming the Remote Controller

When using the remote controller, point it toward the T-4555's remote control sensor, as shown below.

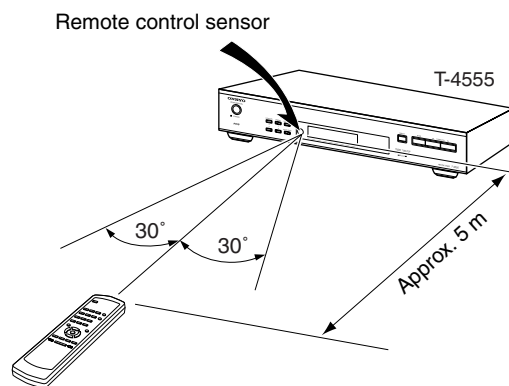

Notes:

- The remote controller may not work reliably if the T-4555 is subjected to bright light, such as direct sunlight or inverter-type fluorescent lights. Keep this in mind when installing.
- If another remote controller of the same type is used in the same room, or the T-4555 is installed close to equipment that uses infrared rays, the remote controller may not work reliably.
- Don't put anything, such as a book, on the remote controller because the buttons may be pressed inadvertently, thereby draining the batteries.
- The remote controller may not work reliably if the T-4555 is installed in a rack behind colored glass doors. Keep this in mind when installing.
- The remote controller will not work if there's an obstacle between it and the T-4555's remote control sensor.

Connecting Antennas

This section explains how to connect the supplied indoor FM antenna, AM loop antenna, and DAB antenna, and how to connect commercially available outdoor FM and AM antennas.

■ European model

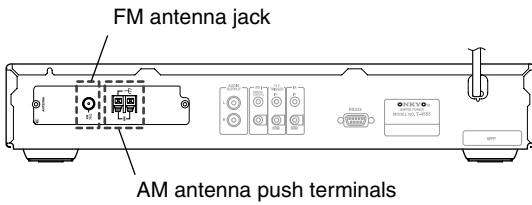

■ U.K. model

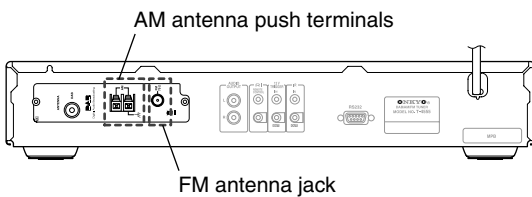

Connecting the Indoor FM Antenna

The supplied indoor FM antenna is for indoor use only.

1 Attach the FM antenna, as shown.

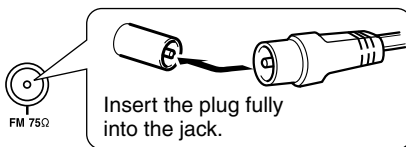

Once the T-4555 is ready for use, you'll need to tune into an FM radio station and adjust the position of the FM antenna to achieve the best possible reception.

2 Use thumbtacks or something similar to fix the FM antenna into position.

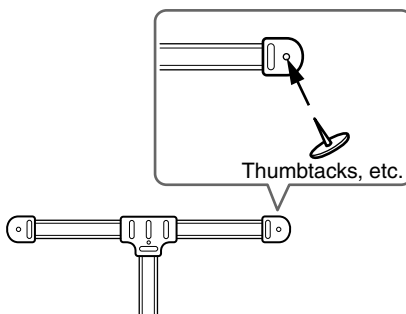

Caution: Be careful that you don't injure yourself when using thumbtacks.

If you cannot achieve good reception with the supplied indoor FM antenna, try using a commercially available outdoor FM antenna instead.

Connecting the AM Loop Antenna

The supplied indoor AM loop antenna is for indoor use only.

1 Assemble the AM loop antenna, inserting the tabs into the base, as shown.

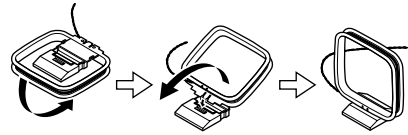

2 Connect both wires of the AM loop antenna to the AM push terminals, as shown.

(The antenna's wires are not polarity sensitive, so they can be connected either way around).

Make sure that the wires are attached securely and that the push terminals are gripping the bare wires, not the insulation.

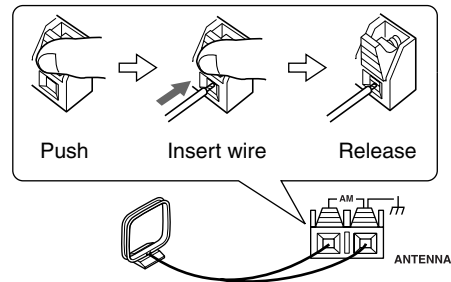

Once the T-4555 is ready for use, you'll need to tune into an AM radio station and adjust the position of the AM antenna to achieve the best possible reception.

Keep the antenna as far away as possible from the T-4555, TV, speaker cables, and power cords.

If you cannot achieve good reception with the supplied indoor AM loop antenna, try using it with a commercially available outdoor AM antenna.

Connecting Antennas—Continued

Connecting the DAB Antenna (C-DAB Tuner Board Only)

1 Screw the supplied DAB antenna's plug onto the DAB ANTENNA jack.

Once the T-4555 is ready for use, you'll need to select a DAB station and adjust the position of the DAB antenna to achieve the best possible reception.

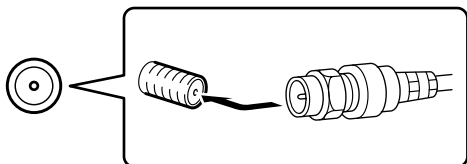

2 Use thumbtacks or something similar to fix the DAB antenna into position.

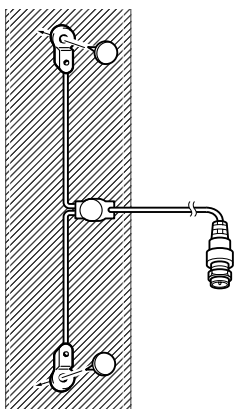

Connecting an Outdoor FM Antenna

If you cannot achieve good reception with the supplied indoor FM antenna, try a commercially available outdoor FM antenna instead.

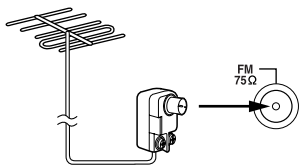

Notes:

- Outdoor FM antennas work best outside, but usable results can sometimes be obtained when installed in an attic or loft.
- For best results, install the outdoor FM antenna well away from tall buildings, preferably with a clear line of sight to your local FM transmitter.
- Outdoor antenna should be located away from possible noise sources, such as neon signs, busy roads, etc.

- For safety reasons, outdoor antenna should be situated well away from power lines and other high-voltage equipment.
- Outdoor antenna must be grounded in accordance with local regulations to prevent electrical shock hazards.

■ Using a TV/FM Antenna Splitter

It's best not to use the same antenna for both FM and TV reception, as this can cause interference problems. If circumstances demand it, use a TV/FM antenna splitter, as shown.

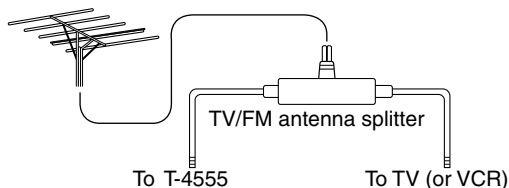

Connecting an Outdoor AM Antenna

If good reception cannot be achieved using the supplied AM loop antenna, an outdoor AM antenna can be used in addition to the loop antenna, as shown.

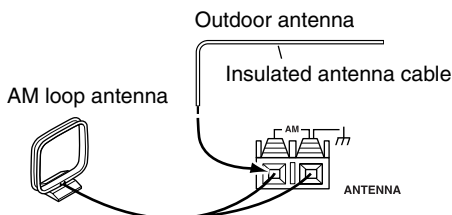

Outdoor AM antennas work best when installed horizontally outside, but good results can sometimes be obtained indoors by mounting horizontally above a window. Note that the AM loop antenna should be left connected.

Outdoor antenna must be grounded in accordance with local regulations to prevent electrical shock hazards.

Connecting the T-4555

Before Making Any Connections

- Refer to the instructions that came with the component you are connecting.
- Do not plug in the power cord until all other connections are complete.
- Do not bind audio cables with power cords and speaker cables. Doing so may adversely affect the sound quality.
- To prevent interference, keep power cords and speaker cables as far away as possible from the antennas.

RCA Audio Connection Color Coding

- Red plugs are used for the right channel, white plugs are used for the left channel.

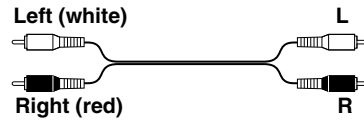

- Push each plug in all the way to make a good connection (loose connections can cause noise or malfunctions).

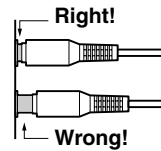

Connecting to an Amplifier

Use the supplied audio cable to connect the T-4555's AUDIO OUTPUT L/R jacks to the TUNER IN jacks on your amplifier, as shown.

To use the **RI** system functions, use the supplied **RI** cable to make an **RI** connection (see the next column).

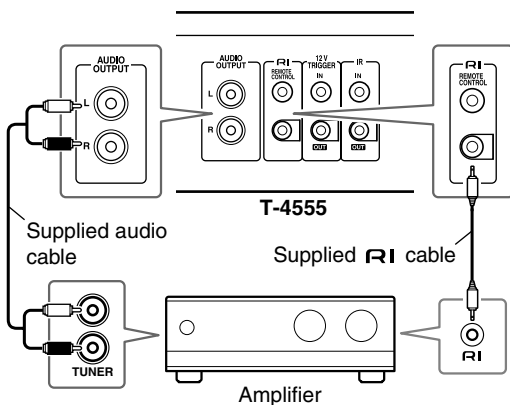

Note:

- If the T-4555 is used with another Onkyo component, such as the A-9555, refer to its instruction manual as well.

About the System Functions

If you connect the T-4555 to another Onkyo **RI**-capable component with the supplied **RI** cable and audio cable, you can use the following system functions. **RI** cables are special cables solely for use with Onkyo products.

Auto Power On

When you turn on the T-4555, your Onkyo amplifier will turn on automatically. (The amplifier's POWER switch must be set to ON for this to work.)

Direct Change

When you select a radio preset or change the band (AM, FM, DAB), your Onkyo amplifier will automatically select the T-4555 as the input source.

Remote Control Operation

You can control the T-4555 by using your Onkyo amplifier's remote controller. See the amplifier's instruction manual for details.

Connecting the T-4555—Continued

With **RI** (Remote Interactive), you can control your **RI**-capable Onkyo CD player, T-4555, and so on with your amp's remote controller.

- To use **RI**, you must make an analog audio connection between your amplifier and each audio component.

Onkyo amplifier
(A-9555), etc.

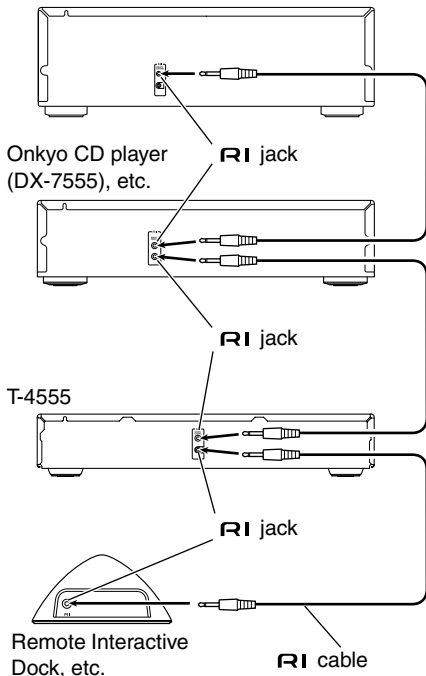

Notes:

- Push each plug in all the way to make a good connection.
- Use only dedicated **RI** cables for **RI** connections. **RI** cables are supplied with Onkyo tuners and players (DVD, CD, etc.).
- Some components, including the T-4555, have two **RI** jacks. They're both the same, so use either one.
- **RI** jacks should be connected only to Onkyo components. Connecting them to another manufacturer's component may cause a malfunction.
- Some components may not support all **RI** functions. See the manuals supplied with your other Onkyo components for more information.

Connecting the 12V Trigger Jacks

To have the T-4555 turn on automatically when another component is turned on, connect the T-4555's 12V TRIGGER IN jack to a 12-volt trigger output on the other component with a miniplug cable.

Likewise, to have another component turn on automatically when the T-4555 is turned on, connect the T-4555's 12V TRIGGER OUT jack to a 12-volt trigger input on the other component with a miniplug cable.

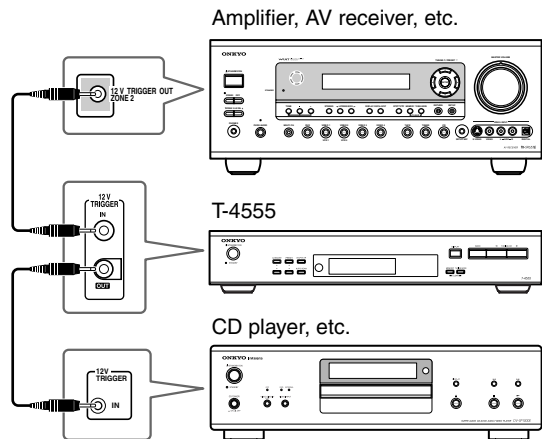

Controlling Components That Are Out of Range

You can use the following multi-room kits to control the T-4555 when it's out of range of the remote controller:

- Multiroom AV distribution and control systems such as those made by Niles® and Xantech®.

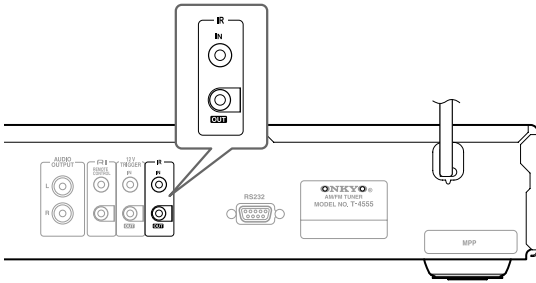

Controlling the T-4555 When It's Out of Range

If the T-4555 is located in another room, installed in a cabinet, or out of range of its remote controller, you can use a commercially available IR receiver to pickup the remote controller signals and feed them to the T-4555, as shown below.

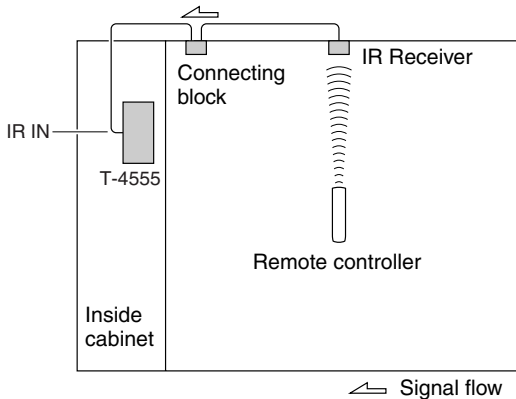

Connect the IR receiver to the T-4555 as shown below.

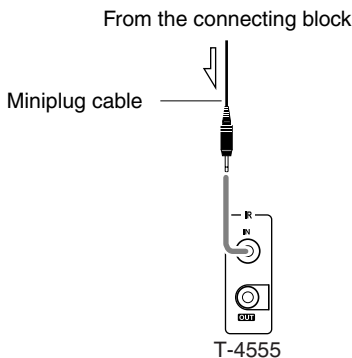

Controlling Other Out-of-range Components

If another component is out of range of its remote controller, you can use a commercially available IR emitter to retransmit the remote controller signals received at the T-4555's IR IN, as shown below.

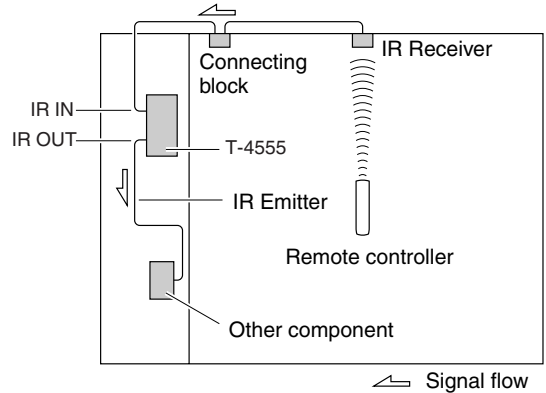

Connect the IR emitter to the T-4555's IR OUT, and place the IR emitter in front of the other component's remote control sensor (usually located on its front panel), as shown below. See the instructions supplied with the IR emitter.

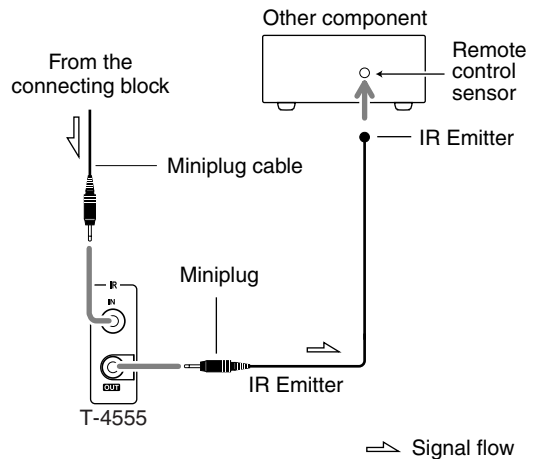

Only remote controller signals received by the T-4555's IR IN are fed through to the IR OUT. Signals picked up by the T-4555's remote control sensor are not output.

Turning On and Listening to AM and FM Radio

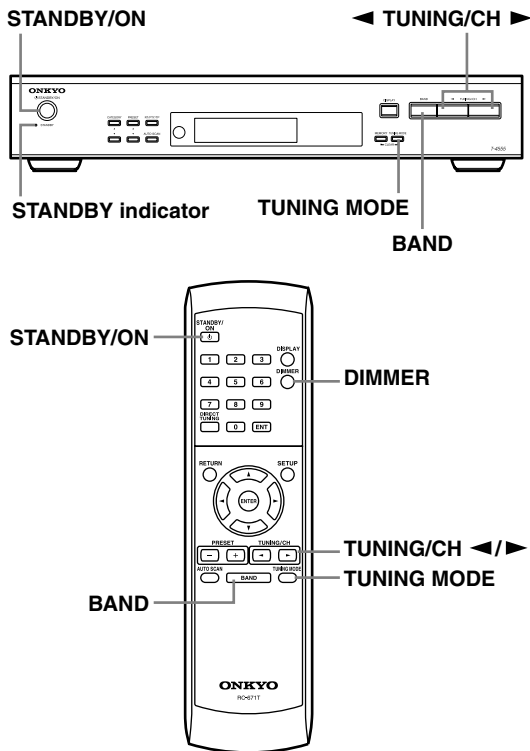

Listening to AM and FM Radio

1 Press the [BAND] button repeatedly to select AM or FM.

The **AM** or **FM** indicator lights up.

Remote controller

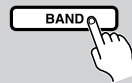

2 Press the [TUNING MODE] button repeatedly to select Auto or Manual Tuning mode.

- **Auto Tuning Mode**
The AUTO indicator appears and stereo radio reception is possible.

- **Manual Tuning Mode**
The MONO indicator appears and radio reception will be in mono.

AUTO indicator
MONO indicator



3 Use the TUNING/CH [◀]/[▶] buttons to tune into a station.

In Auto Tuning mode, once a station is found, tuning stops automatically.

This model changes FM frequency in 0.05 MHz steps, 9 kHz steps for AM.

In Manual Tuning mode, the frequency stops changing when you release the buttons. Press the buttons repeatedly to change the frequency one step at a time.

When tuned into a station, the **▶ TUNED ◀** indicator appears.

▶ TUNED ◀

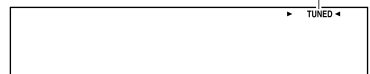

Turning On the T-4555

1 Connect the power cord to a suitable wall outlet.

2 Press the [STANDBY/ON] button on the T-4555 or remote controller.



The T-4555 turns on, and the STANDBY indicator goes off.

Remote controller



To turn off the T-4555, press the [STANDBY/ON] button. The T-4555 will enter Standby mode.

Note that the T-4555 is not completely shutdown in Standby mode.

Setting the Display Brightness

With this function, you can adjust the brightness of the display.

Remote controller



Press the remote controller's [DIMMER] button repeatedly to select: dim, dimmer, or normal brightness.

Tuning into weak stereo FM stations

If the signal from a stereo FM station is weak, it may be impossible to get good reception. In this case, switch to Manual Tuning mode and listen to the station in mono.

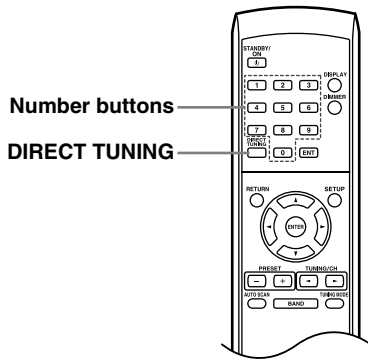

Tuning into Stations by Frequency

You can tune into AM and FM stations directly by entering the appropriate frequency.

<p>1</p> <p>Remote controller</p>	<p>Press the [DIRECT TUNING] button.</p> <p>(Actual display depends on country.)</p>
<p>2</p> <p>Remote controller</p>	<p>Within 8 seconds, use the number buttons to enter the frequency of the radio station.</p> <p>For example, to tune into an FM station at 87.5 MHz, press [8], [7], and [5].</p>

Adjusting the Antennas

Adjusting and installing the FM antenna

Choose a location for the FM antenna while listening to an FM station.

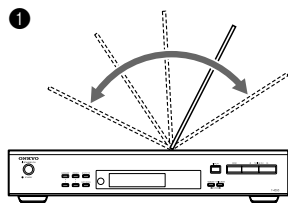

Change the direction of the antenna to achieve the best possible reception.

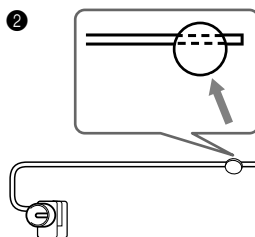

Affix the antenna with a thumbtack. (Do not push the thumbtack *through* the antenna.)

Caution: Be careful not to prick your finger!

Adjusting the AM antenna

Adjust the location and position of the AM antenna while listening to an AM station to achieve the best possible reception.

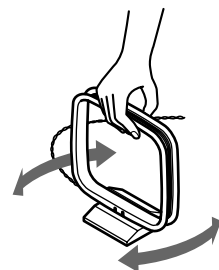

Using RDS

RDS only works with European and U.K. models and only in areas where RDS broadcasts are available.

■ What is RDS?

RDS stands for *Radio Data System* and it's a method of transmitting data in FM radio signals. It was developed by the European Broadcasting Union (EBU) and is available in most European countries. Many FM stations use it these days. In addition to displaying text information, RDS can also help you find radio stations by type (e.g., news, sport, rock, etc.).

The T-4555 supports the following types of RDS data:

PS (Program Service)

When tuned to an RDS station that's broadcasting PS information, the station's name will be displayed. Pressing the [DISPLAY] button will display the current frequency for 3 seconds.

RT (Radio Text)

When tuned to an RDS station that's broadcasting RT text information, the text will be shown on the display (see page 18).

PTY (Program Type)

With PTY, you can search for radio stations by type (see page 18).

TP (Traffic Program)

With TP, you can listen to traffic information (see page 18).

Notes:

- In some cases, the text characters displayed on the AV receiver may not be identical to those broadcast by the radio station. Also, unexpected characters may be displayed when unsupported characters are received. This is not a malfunction.
- If the signal from an RDS station is weak, RDS data may be displayed intermittently or not at all.

Program Types Used in Europe (PTY)

Type	Display	Description
None	NONE	No program type.
News reports	NEWS	Reports on current events and happenings.
Current affairs	AFFAIRS	Topical reporting of current affairs, often with a wider range of topics than news reports.
Information	INFO	General information such as weather forecasts, consumer affairs, medical help, etc.
Sport	SPORT	Live sports action, sports news, and interviews.
Education	EDUCATE	Formal educational programs.
Drama	DRAMA	Radio plays and serials.
Culture	CULTURE	Cultural programs (including religious affairs).
Science and technology	SCIENCE	Programs about the natural sciences and technology.
Varied	VARIED	Speech-based programs not covered by the above categories (e.g., quizzes, panel games, and comedy).
Pop music	POP M	Popular commercial music, usually from past or present sales charts (e.g., Top 40).
Rock music	ROCK M	Popular music with an alternative appeal, often not appearing on sales charts.
Middle of the road music	M.O.R.M	Easy listening music (as opposed to Pop, Rock, or Classical).
Light classics	LIGHT M	Classical music for general rather than specialist appreciation.
Serious classics	CLASSICS	Performances of major orchestral works, symphonies, chamber music, etc. (including the Grand Opera).
Other music	OTHER M	Music styles not covered by the above categories (e.g., Jazz, Rhythm & Blues, Folk, Country, and Reggae).
Alarm	ALARM	When an RDS station is making an emergency broadcast, ALARM will flash on the display.

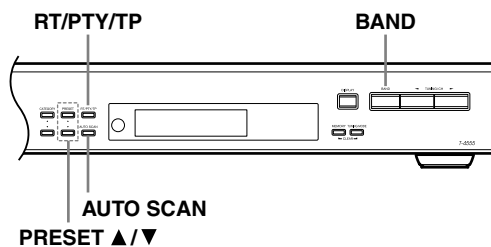

Displaying Radio Text (RT)

When tuned to an RDS station that's broadcasting RT text information, you can display information.



Press the [RT/PTY/TP] button once.
The RT information scrolls across the display.

Notes:

- While the T-4555 waits for RT information, “Waiting” appears on the display.
- If “No Text Data” appears on the display, no RT text information is available.

Finding Stations by Type (PTY)

You can search for radio stations by type.

1



Use the [BAND] button to select FM.

2



Press the [RT/PTY/TP] button twice.
The current program type appears on the display.

3



Use the PRESET [▲]/[▼] buttons to select the type of program you want.
See the list of program types on page 17.

4



To start the search, press [AUTO SCAN].
The T-4555 searches until it finds a station of the type you specified, at which point it stops briefly before continuing with the search.

5



When the station you want to listen to is found, press [AUTO SCAN].
If no stations are found, “Not Found” appears on the display.

Listening to Traffic Information (TP)

You can listen to traffic information and search for TP radio stations.

1

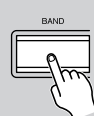

Use the [BAND] button to select FM.

2



Press the [RT/PTY/TP] button three times.
If the current radio station is broadcasting TP (Traffic Program), “[TP]” will appear on the display and traffic information will be heard as and when it's broadcast. If “TP” without square brackets appears, it means that the station is not broadcasting TP.

3



To locate a station that is broadcasting TP, press [AUTO SCAN].
The T-4555 searches until it finds a station that's broadcasting TP.
If no stations are found, “Not Found” appears on the display.

Listening to DAB Digital Radio

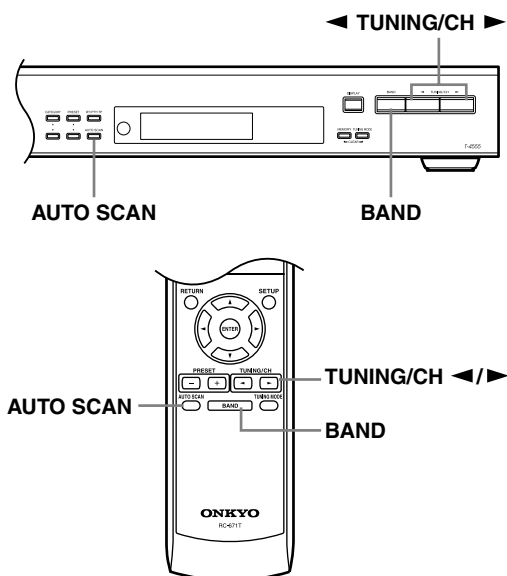

Press the [BAND] button repeatedly to select DAB.
The **[DAB]** indicator lights up.

When tuned into a DAB station, the **▶ TUNED ◀** indicator appears.

DAB indicator ▶ Tuned ◀ indicator

Station name

Selecting DAB for the Very First Time

The very first time you select DAB, the Auto Tuning function automatically scans the DAB Band III and L-Band for the multiplexes (i.e., stations) available in your area.

Once the scanning process is complete, the first station that was detected is selected.

Using the Auto Tuning Function Manually

If a new DAB station is introduced, or you move to a new area, you can run the Auto Tuning function again.

To start the Auto Tuning function, press the [AUTO SCAN] button.
The number of stations found and the scanning progress are shown on the display.

To cancel Auto Tuning, press the [AUTO SCAN] button again.

Selecting DAB Stations

Use the TUNING/CH [◀]/[▶] buttons to select a DAB station.
If a secondary service is available, a right angle bracket (>) is displayed. Press the Right Arrow [▶] button to listen to the secondary service.

While the secondary service is selected, a left angle bracket (<) is displayed and **SECONDARY** indicator lights up. Press the Left Arrow [◀] button to return to the primary service.

"SECONDARY"

When you select a station that you've selected a lot in the past, the letter **F** (short for *Favorite*) is displayed.

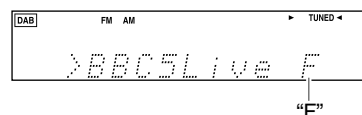

If you select a station that cannot be received properly, a question mark (?) is displayed.

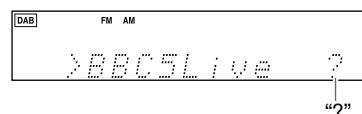

Displaying DAB Radio Information

Press the [DISPLAY] button repeatedly to display more information about the current DAB station.

1. DLS (Dynamic Label Segment)

When tuned to a station that's broadcasting DLS text data, the text will scroll across the display.

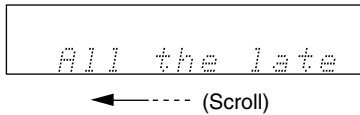

2. Program Type

Displays the type of program.

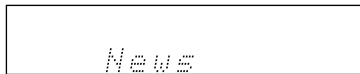

3. Bit Rate and Audio Mode

Displays the station's bit rate and audio mode (stereo, mono, or joint stereo).

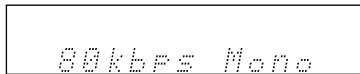

4. Signal Quality

Displays the signal quality.

0–59: Poor reception

60–79: Good reception

80–100: Excellent reception

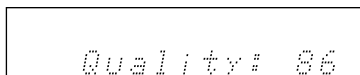

5. Multiplex Name

Displays the name of the current multiplex.



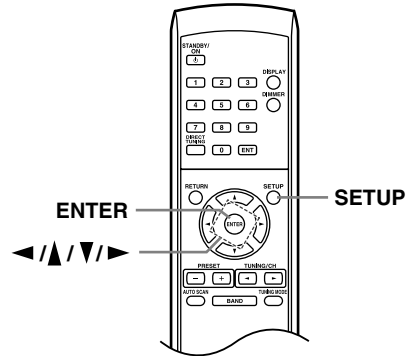
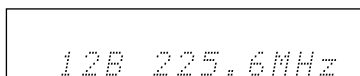

6. Multiplex Number and Frequency

Displays the number and frequency of the current multiplex.



DAB Setup

You can configure DAB digital radio with these settings.

1 Remote controller SETUP 	Press the [SETUP] button.
2 Remote controller 	Use the Up and Down Arrow [▲]/[▼] buttons to select a setting. Each item is explained below.

St. List (Station Listing)

With this setting, you can sort the available stations alphabetically, by multiplex, favorites, or active stations. Use the Left and Right Arrow [◀]/[▶] buttons to select the following options, and then press [ENTER].

Alp Odr (Alphabetical Order): Sort stations alphabetically. This is the default setting.

Mlt Odr (Multiple Order): Sort stations by multiplex.

Fav Odr (Favorite Order): Sort stations by favorites. The stations you select the most will appear at the top of the list.

Act Odr (Active Station Order): Sort by active stations. Receivable stations appear at the top of the list. stations that cannot be received properly appear at the bottom of the list.

Trim (Trim Station): Removes stations that cannot be received properly from the listing.

Scan Mode

This setting determines which DAB bands are scanned by the Auto Tuning function (see page 19).

Use the Left and Right Arrow [◀]/[▶] buttons to select the following options, and then press [ENTER].

UK: Band III (11B–12D).

WorldW (Worldwide): Band III (5A–13F) and L-Band (LA–LW). This is the default setting.

DRC Value

With the DRC (Dynamic Range Control) setting, you can reduce the dynamic range of DAB digital radio so that you can still hear quiet parts even when listening at low volume levels—ideal for listening to the radio late at night when you don't want to disturb anyone.

Use the Left and Right Arrow [◀]/[▶] buttons to select from the following options, and then press [ENTER].

1 (default): Large reduction in dynamic range.

1/2: Small reduction in dynamic range.

0: DRC off.

Band

With the Band setting, you can choose the DAB band you want to use, and display the current reception quality and the reception quality necessary to decode the current multiplex.

Use the Left and Right Arrow [◀]/[▶] buttons to select from the following options, and then press [ENTER].

Band III: 5A–13F

L-Band: LA-LW

Display example:

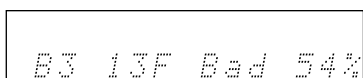

Channel

If reception is poor, "Bad" is displayed. If reception is good, "Good" is displayed.

You can adjust the position and direction of the DAB antenna while monitoring the signal strength on the display.

To make "Good" appear, adjust the antenna to get the best signal strength.

Using Presets

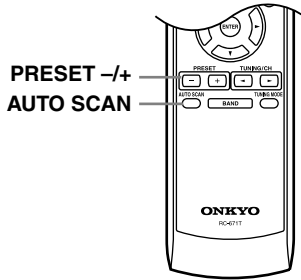
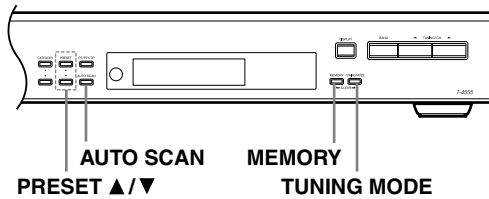

Presetting Your Favorite Stations

You can store any combination of up to 40 of your favorite AM, FM, and DAB radio stations as presets.

■ Using the T-4555:

- 1** Tune into the station that you want to store as a preset.
- 2** Press the [MEMORY] button. The MEMORY indicator appears and the preset number flashes.



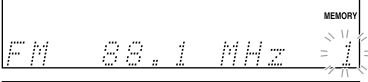
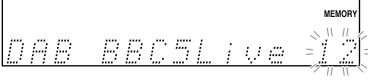

- 3** While the MEMORY indicator is displayed (about 8 seconds), use the PRESET [▲]/[▼] buttons to select a preset from 1 through 40.

- 4** Press the [MEMORY] button again to store the station or channel. The station or channel is stored and the preset number stops flashing. Repeat this procedure for all of your favorite radio stations.



Selecting Presets

■ Using the PRESET buttons:



Remote controller



To select a preset, use the T-4555's PRESET [▲]/[▼] buttons, or the remote controller's PRESET [+]/[-] buttons.

■ Using the Auto Scan function:



Remote controller



Press the [AUTO SCAN] button. The Auto Scan function automatically selects and outputs each radio preset in turn for 5 seconds. When you hear the station that you want to listen to, press the [AUTO SCAN] button again to stop auto scanning.

Deleting Presets

■ Using the T-4555:

- 1** Select the preset that you want to delete. See the previous section.
- 2** While holding down the [MEMORY] button, press the [TUNING MODE] button. The preset is deleted and its number disappears from the display.

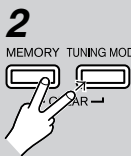



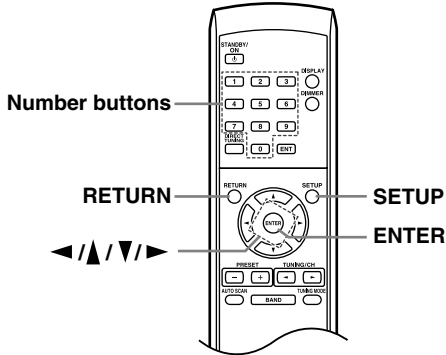

Changing the Remote ID

If the T-4555's remote controller interferes with other Onkyo components located in the same room, you can change the remote control ID. You can select remote control ID #1, #2, or #3. By default, the remote control ID is set to #1. If you change the ID, you must also change the ID on the remote controller to match, as explained below, otherwise, the remote controller won't work.





Changing the T-4555's Remote ID

<p>1 Remote controller SETUP</p> 	<p>Press the [SETUP] button.</p>
<p>2 Remote controller</p> 	<p>Use the Up and Down Arrow [▲]/[▼] buttons to select "Hardware Setup," and then press [ENTER].</p> <p>With some tuner boards, there will only be one option available and you won't need to use the Up and Down Arrow [▲]/[▼] buttons.</p>
<p>3 Remote controller</p> 	<p>Use the Up and Down Arrow [▲]/[▼] buttons to select "Remote ID."</p> <p>With some tuner boards, there will only be one option available and you won't need to use the Up and Down Arrow [▲]/[▼] buttons.</p>

<p>4 Remote controller</p> 	<p>Use the Left and Right Arrow [◀]/[▶] buttons to change the remote ID.</p> <p>You can select ID #1 (default), #2, or #3.</p>
<p>5 Remote controller SETUP</p> 	<p>Press the [SETUP] button.</p> <p>Once you've changed the T-4555's remote ID, the remote controller will no longer control the T-4555, so you must change the remote controller's ID to match, as explained below.</p>

Changing the Remote Controller's ID

<p>1</p>	<p>Before changing the remote controller's ID, change the T-4555's ID first (see above).</p>
<p>2 Remote controller RETURN</p> 	<p>Press the remote controller's [RETURN] button.</p>
<p>3 Remote controller RETURN</p> 	<p>While pressing and holding down the remote controller's [RETURN] button, press number button [1], [2], or [3] for 3 seconds to select ID #1, #2, or #3 respectively.</p>
<p>4</p>	<p>Check whether the remote controller operates the T-4555 properly.</p>

Note:

- The remote controller and T-4555 must be set to the same remote control ID. Otherwise, you won't be able to control the T-4555 with the remote controller.

Optional Tuner Boards

The following optional tuner boards are available for the T-4555:

- For T-4555 European model: C-DAB board (AM/FM/DAB tuner)
- For T-4555 U.K. model: C-AMFM board (AM/FM tuner)

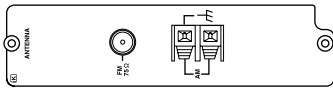
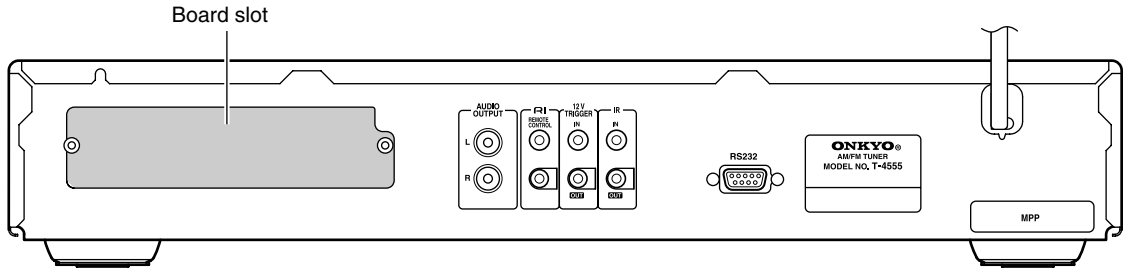

Product number: C-AMFM
Provides terminals for FM and AM tuners.

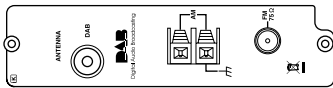



Product number: C-DAB
Provides terminals for DAB, FM stereo and AM tuners.



Caution:

- Before installing or removing a board, be sure to turn off the T-4555 and unplug the power cord from the wall outlet. Failure to do so could seriously damage your equipment.

AM Frequency Step Setup

In most cases, you do not need to perform the following procedure. However, if the purchased board is the worldwide model and you plan to use it in Europe or U.K., you must change the AM Frequency setting to 9 kHz steps. Follow the procedure below after you install the board.

1 Remote controller SETUP 	Press the [SETUP] button.
2 Remote controller  ↓ 	Use the Up and Down Arrow [▲]/[▼] buttons to select “Hardware Setup,” and then press [ENTER]. With some tuner boards, there will only be one option available and you won’t need to use the Up and Down Arrow [▲]/[▼] buttons.

3 Remote controller 	Use the Up and Down Arrow [▲]/[▼] buttons to select “AM Freq.” With some tuner boards, there will only be one option available and you won’t need to use the Up and Down Arrow [▲]/[▼] buttons.
4 Remote controller 	Use the Left and Right Arrow [◀]/[▶] buttons to select: 9 kHz: Select if 9 kHz steps are used in your area. 10 kHz: Select if 10 kHz steps are used in your area.
5 Remote controller SETUP 	Press the [SETUP] button.

Installing a Board

Use the Allen wrench, hexagonal socket head screws, removal thumbscrews, and so on supplied with the board.

- 1** Turn off the T-4555, and then unplug the power cord from the wall outlet.
- 2** Use the supplied Allen wrench to unscrew the two hexagonal socket head screws that are securing the existing board or blanking plate.

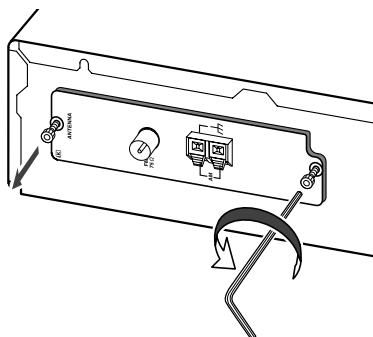

- 3** Screw the supplied removal thumbscrews into the two holes just below the holes that were used by the hexagonal socket head screws. Screw them in about 3/16" (5 mm). Hold and pull both of the thumbscrews to remove the board.

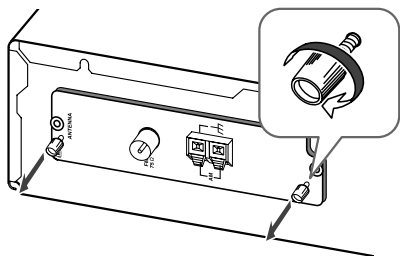

- 4** Carefully remove the board from its bag.

To prevent electrostatic damage, hold the board by its panel, taking care not to touch any of the components or the underside of the circuit board with your bare hands.

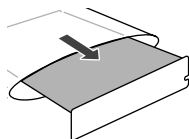

- 5** Insert the board between the guide rails and push it in.

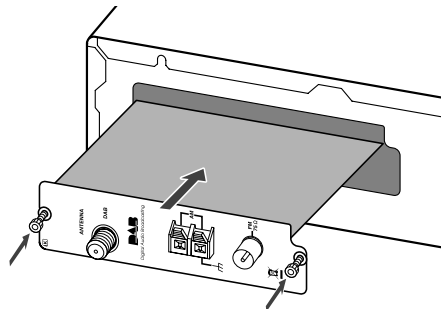

When the board meets the internal connector, apply a little more pressure so that the board plugs fully into the connector. Make sure the board's panel is flush with the T-4555's rear panel.

- 6** Use the Allen wrench to screw tight the two hexagonal socket head screws so that the board is secure.

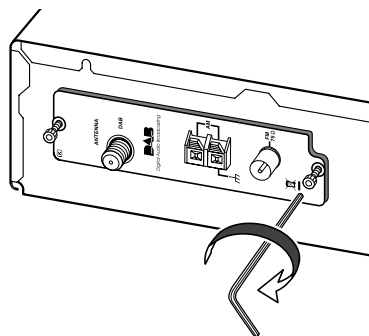

Be sure to fully tighten the screws. If they are loose, the ground connection between the board and the T-4555 may be inadequate, resulting in noise or failure.

Caution:

If any of the screws use washers, be sure to reuse them when installing or removing a board.

Troubleshooting

If you have any trouble using the T-4555, look for a solution in this section.

If you can't resolve the issue yourself, try resetting the T-4555 before contacting your Onkyo dealer.

To reset the T-4555 to its factory defaults, turn it on and, while holding down the [MEMORY] button, press the [STANDBY/ON] button. "Clear" will appear on the display and the T-4555 will enter Standby mode.

Note that resetting the T-4555 will delete your radio presets and custom settings.

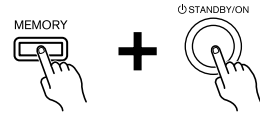

Power

Can't turn on the T-4555.

- Make sure that the power cord is properly plugged into the wall outlet (see page 15).
- Unplug the power cord from the wall outlet, wait 5 seconds or more, then plug it in again.

Audio

There's no sound.

- Make sure your amplifier's volume control is not set to minimum.
- Check all connections and correct as necessary (see pages 10 to 14).

Tuner

Reception is noisy, stereo FM reception suffers from hiss, or the STEREO indicator doesn't light up when tuned to a stereo FM station.

- Check the antenna connections (see page 10).
- Change the position of the antenna (see page 16).
- Move the T-4555 away from a nearby TV or computer.
- Cars or airplanes can cause noisy interference.
- The radio signal will be weakened if it has to pass through a concrete wall before reaching the antenna.
- Try selecting Manual Tuning mode (mono) (see page 15).
- Move power cords and speaker cables as far away as possible from the antenna.
- When listening to an AM station, noise may be heard when you operate the remote controller.
- If none of the above improves the reception, install an outdoor antenna (see page 11).

If a power outage occurs or the power cable is disconnected:

- If the preset stations are lost, preset them again (see page 22).

Can't adjust the frequency of the radio.

- Use the TUNING/CH [◀]/[▶] buttons to change the frequency of the radio (see page 15).

RDS doesn't work.

- The FM station you are tuned to doesn't support RDS.
- Install an outdoor FM antenna (see page 11).
- Change the position or direction of your outdoor FM antenna (see page 11).
- Move the FM antenna as far away as possible from fluorescent lights (see page 11).

Troubleshooting—Continued

Remote Controller

The remote controller doesn't work properly.

- Make sure the batteries have been installed with the correct polarity (+/–) (see page 9).
- Replace both batteries with new ones. (Do not mix different types of batteries or new and old batteries.)
- The remote controller is too far away from the T-4555, or there's an obstacle between them (see page 9).
- The T-4555's remote control sensor is being subjected to bright light (inverter-type fluorescent light or sunlight).
- The T-4555 is located behind the glass doors of a audio rack or cabinet.
- The T-4555 and remote controller may be set to different remote control IDs. Set the T-4555's remote control ID first, and then set the remote controller to the same ID (see page 23).

Others

Interactive control with other Onkyo RI-capable components is not working.

- Make sure the **RI** cables and analog audio cables are connected correctly (see page 12). Connecting only an **RI** cable won't work.

The T-4555 contains a microcomputer for signal processing and control functions. In very rare situations, severe interference, noise from an external source, or static electricity may cause it to lock up. In the unlikely event that this should happen, unplug the power cord, wait at least 5 seconds, and then plug it again.

Specifications

General	
Power Supply:	AC 230 V, 50 Hz
Power Consumption:	14.5 W (when C-DAB board is used)
Stand-by Power Consumption:	0.45 W
Dimensions (W × H × D):	European model: 435 × 81 × 310 mm, U.K. model: 435 × 81 × 315 mm
Weight:	European model: 4.6 kg, U.K. model: 4.7 kg

FM	
Tuning frequency range:	87.5–108.0 MHz
Usable sensitivity:	Stereo: 22.2 dBf (IHF) Mono: 15.2 dBf (IHF)
Signal-to-noise ratio:	Stereo: 67 dB (IHF-A) Mono: 73 dB (IHF-A)
THD (total harmonic distortion):	Stereo: 0.5% (1 kHz) Mono: 0.3% (1 kHz)
Stereo separation:	40 dB (1 kHz)

AM	
Tuning frequency range:	522–1611 kHz
Usable sensitivity:	300 μV
Signal-to-noise ratio:	40 dB
THD (total harmonic distortion):	0.7%

DAB (U.K. model only)	
Tuning frequency range:	174.928–239.200 MHz
Frequency response:	20 Hz–20 kHz
Signal-to-noise ratio:	94 dB
THD (total harmonic distortion):	0.09%

Specifications and features are subject to change without notice.

ONKYO CORPORATION

Sales & Product Planning Div. : 2-1, Nisshin-cho, Neyagawa-shi, OSAKA 572-8540, JAPAN
Tel: 072-831-8023 Fax: 072-831-8124

ONKYO U.S.A. CORPORATION

18 Park Way, Upper Saddle River, N.J. 07458, U.S.A.
Tel: 201-785-2600 Fax: 201-785-2650 <http://www.us.onkyo.com/>

ONKYO EUROPE ELECTRONICS GmbH

Liegnitzerstrasse 6, 82194 Groebenzell, GERMANY
Tel: +49-8142-4401-0 Fax: +49-8142-4401-555 <http://www.eu.onkyo.com/>

ONKYO EUROPE UK Office

Suite 1, Gregories Court, Gregories Road, Beaconsfield, Buckinghamshire, HP9 1HQ
UNITED KINGDOM Tel: +44-(0)1494-681515 Fax: +44(0)-1494-680452

ONKYO CHINA LIMITED

Unit 1&12, 9/F, Ever Gain Plaza Tower 1, 88, Container Port Road, Kwai Chung,
N.T., HONG KONG Tel: 852-2429-3118 Fax: 852-2428-9039
<http://www.ch.onkyo.com/>



I0608-1

SN 29344319

(C) Copyright 2006 ONKYO CORPORATION Japan. All rights reserved.



* 2 9 3 4 4 3 1 9 *